

EVOSET

TOOL SHRINK
Basic

USER
INSTRUCTIONS



IMPORTANT CAUTIONS & WARNINGS

The Tool Shrink Basic is built with the latest technology and it is extremely safe and easy to operate. However, there is still some danger if this device is operated incorrectly and/or by untrained personnel. Pay particular attention to the following cautions and warnings marked with the “Attention” and “Danger” symbols. Failure to follow safe operating practices may cause injuries, death or damage to the device and may VOID your manufacturer's warranties.



- Before attempting to use the device, you must read and fully understand this User Guide. Keep this User Guide within easy reach of operating personnel.
- Visually inspect the device, power cord and accessory items for any signs of wear or damage before operating the device. Do not use the device if there is any sign of damage or if the device is not performing normally.
- Never operate the device without the correct induction heat-focusing stopper in place on the induction head. Do not allow any part of the induction head to contact the tool holder or cutting tool during operation or damage to the device may occur.
- The holder and the tool must be clean, free from grease and dry before being fitted to the device.

- Tool shank tolerance required: $\text{Ø}3$ to 5 mm ($\text{Ø}0.118''$ to $0.1968''$) maximum h5. Tool shank must be carbide or heavy metal (e.g. Densimet). $\text{Ø}6$ to $\text{Ø}32\text{ mm}$ ($\text{Ø}0.236''$ to $\text{Ø}1.25''$) maximum h6. Tool shank can be steel, HSS, carbide or heavy metal. Using h5 for $\text{Ø}6$ to $\text{Ø}32\text{ mm}$ ($\text{Ø}0.236''$ to $\text{Ø}1.2598''$) provides a safer minimum clamping torque.
- Do not wear rings, bracelets or other metallic objects while operating the device. Metallic objects may heat up very quickly when near the induction head during operation.



- Use the provided heat-resistant gloves and pliers whenever handling tools or tool holders. Never try to handle hot tools or tool holders until the cooling cycle is complete.
- If the device is moved from a cold environment to a warm one, wait three hours before operating to prevent build-up of condensation and electronic system errors.
- **Persons with pacemakers fitted may not operate the device and must maintain a minimum safe distance of 2 meters (6 feet) from the device at all times.**
- Cutting tools have sharp edges. Handle with caution.



- The power cord provided must be plugged into the correct standard, three-phase outlet for your country. Operating the device while it is improperly connected or at the wrong voltage may damage the device and could cause death or injury.
- Position the power cord so that it cannot be damaged by fork trucks or other equipment or cause a tripping hazard for personnel.
- Do not operate the device in a wet environment where exposure to coolant or spills are likely to occur. Electric shocks or damage to the device may occur.
- Never operate the device around flammable materials or fumes. Do not use flammable liquids or aerosols to clean the tool holders. Never expose the device or hot tools to combustible materials.
- Never open the device or attempt repairs or you will VOID the manufacturer's warranty. There is dangerous residual voltage inside that may cause death or injury.
- Unauthorized modifications or changes to the Tool Shrink Basic device will VOID your manufacturer's warranty. Do not try and service your device yourself. After-sales technicians can provide any necessary repairs or maintenance. Do not modify or disable the built-in safety features of the device.
- Turn off the power switch and disconnect the power cord from the outlet before cleaning, servicing or storing the device.



CONTENT

Device general overview	4
Accessories and spare parts	5
Tool Shrink Basic features.....	6
Range overview.....	7
Refrigeration unit	7
Refrigerated water-cooling bells unit.....	8-11
Taking delivery.....	12
Working environment of the device	12
Keypad and display presentation .	13
Starting the device	13

Starting to shrink and unshrink ...	14
Shrinking depths to be respected	14
Mode selection	15
Shrinking process.....	16-17
Shrink release.....	18
Audible feedback	18
Boost mode.....	18
Shrinkfit of special tools	19-20
Shrink release of special tools	21-22
Shrinking capability	22
Web interface	23-25

Shrink fitting settings.....	26
How to check the resistance of the tool holders?.....	27
How to add special tool holders?...	28
Error information.....	29
Default values in the tables	30-32
Maintenance frequency.....	33
Safety precautions.....	34
Annexes.....	35
Technical features	35
Compliance statements	36-37

GENERAL OVERVIEW

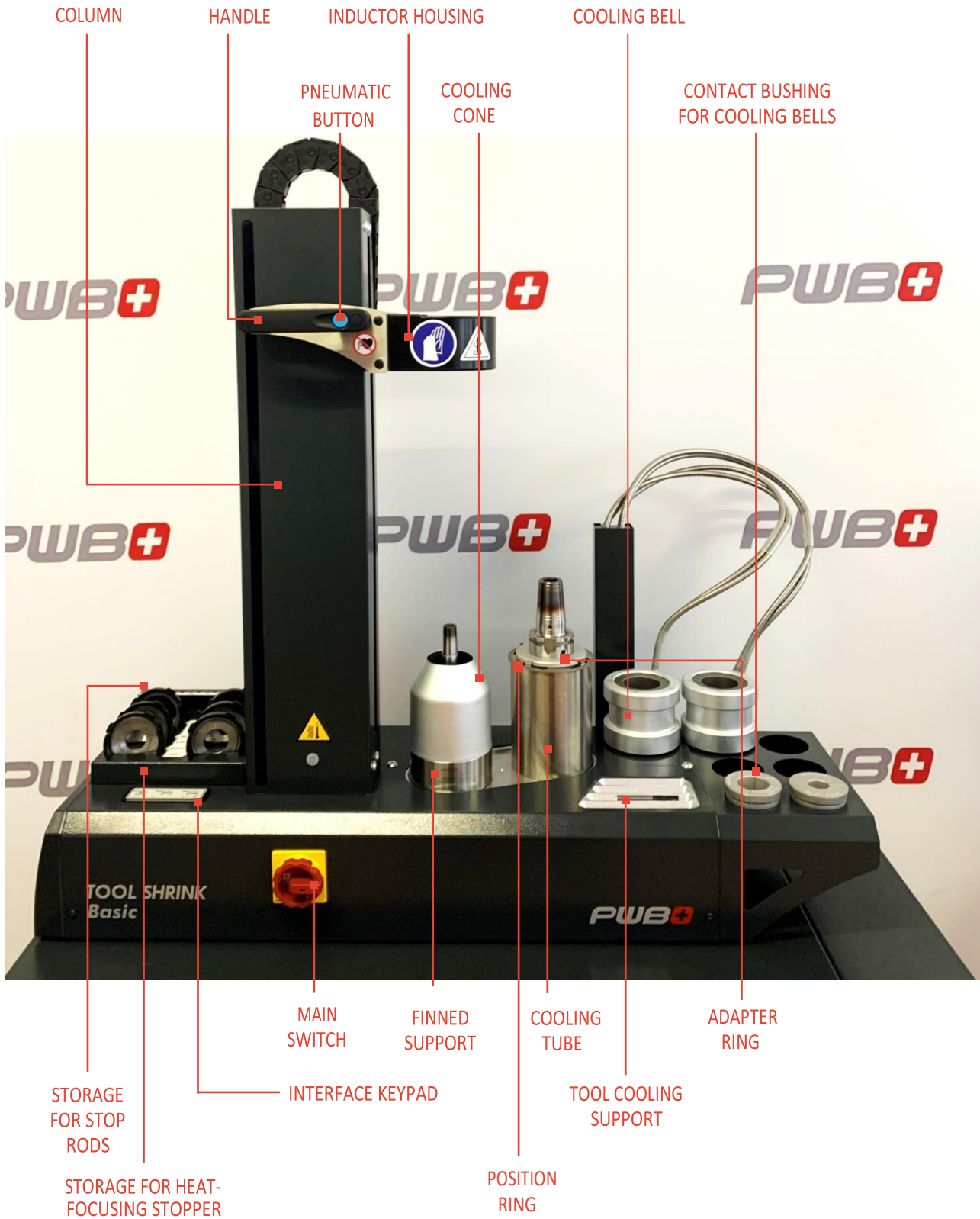

ACCESSORIES AND SPARE PARTS

Important: These accessories related to the Shrinkfit tool holders must be ordered separately in order to use the **TOOL SHRINK BASIC**.

REQUIRED AS A MINIMUM FOR SHRINK GRIP AND SHRINK RELEASE OPERATIONS

- Finned supports and adapter ring for each type of machine side taper used on Shrinkfit tool holders. Available for all types of tool holder (HSK / DIN & DIN TF / BT & BT TF / CAT & CAT TF / Capto).

Provides positioning of the tool holder onto the support module.

REQUIRED AS A MINIMUM FOR THE WATER COOLER

- Contact bushing for each type and size of Shrinkfit tool holder used. Available for all types of Shrinkfit holders and diameters (DIN type / Reinforced / Mold and Die / MQL)

Required to extract heat from the front end of the holder towards the liquid cooling bell.

SPARE PARTS

- Air cooling cones.

Directs the air stream against the front end of the holder for cooling

- Heat-focusing stoppers.

Available for shrinking and unshrinking tool holders $\text{Ø}3$ to $\text{Ø}32$ mm ($\text{Ø}0.118$ " to $\text{Ø}1.26$ ").

Magnetic insulator that allows the magnetic field to be concentrated on the front part of the tool holder and to achieve optimised heating.

- Split heat-focusing stoppers.

Split magnetic insulator that allows the magnetic field to be concentrated on the front part of the tool holder and to achieve optimised heating of tools with a front end that is larger than shank.



Finned support



Adapter ring



Contact bushing



Air cooling cone



Standard heat-focusing stopper



Split heat-focusing stopper

TOOL SHRINK BASIC FEATURES

INDUCTOR

Fast and optimized cycle for shrinking and unshrinking steel, HSS, heavy metal or carbide tools with standard DIN type Tool holders

HEAT-FOCUSING STOPPERS

Enable the shrinking or unshrinking of carbide or HSS tools Ø3 to Ø32 mm (0.118" to 1.260").
NB: Split heat-focusing stoppers available as accessories for larger head tools.

COLUMN

Enables the shrinking and unshrinking of tool holders with a maximum length of:

- 480 mm (18.897") with HSK-32 finned support
- 430 mm (16.930") with SA50 finned support
- 490 mm (19.290") with other finned support



SMART

- Small computer that enables a smart web interface through a Wi-Fi connection or by RJ45
- TDM Systems compatible
- Special program is easily programmable
- Global view of the system status

INTERFACE

- Simple control panel with LED indicator
- 3 standard programs for all DIN 4.5°; DIN 3° holders
- 1 programmable mode for other tool holders (specific shape or competitors)
- 1 manual mode

RANGE OVERVIEW

TOOL SHRINK BASIC

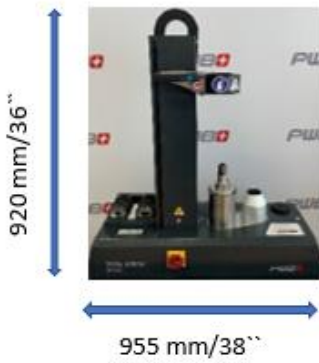

TOOL SHRINK BASIC & TOOL COOLING SUPPORT

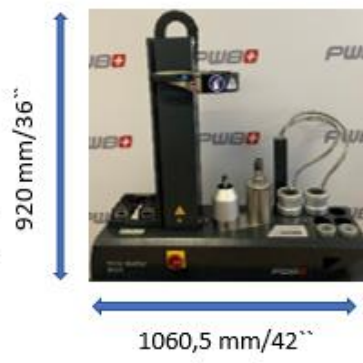

COOLING UNIT



TOOL SHRINK BASIC

FEATURES

- Power: 16 kW allows the shrinking and unshrinking of tools Ø3 to Ø32 mm (Ø0.118" to Ø1.26")
- Max. tool length: 430 to 490mm
- Max. machine interface: HSK-A125
- Dimensions (W x D x H): 317 x 955 x 920 mm / 12.5" x 38" x 36"
- Cooling time: ± 7 minutes with cooling cones
- Weight: 46.2 kg (102 lbs)

DELIVERY CONTENT

- 5 standard heat-focusing stoppers for Ø3 to Ø32 mm (Ø0.118" to Ø1.26")
- 1 cooling tube L=150mm
- 1 cooling cones
- 1 position-ring
- 1 adapter-ring
- 1 pair of gloves
- 1 operating instructions



CONNECTIONS

- The device accepts the voltage AC 3 x 400 V (+/-10%)+ PEN/23.8 A/50-60 Hz
- AC 3x 400 V (+/-10%)+PE+N/23.8A/50-60 Hz
- AC 3x 440-480 V+ GND / 23.8 A / 50-60 Hz

For other voltages the use of a transformer is required, which needs to be bought separately:

- Input voltages: 3 x 208 / 240 / 480 / 600 VAC + GND/28A/50-60 Hz
- Output voltages: AC 3 x 400 V+N + PE/28 A/50-60 Hz
- 2.50 meter cable is supplied
- Air 3 to 6 bars/duct Ø 10 mm required



OPTIONAL PRODUCT

REFRIGERATION UNIT

FEATURES

- Cooling time: ± 1 minutes
- Extension table: Allow storage of 5 contact bushing and 1 cooling bell
- Weight: 39.8 kg (88 lbs)

DELIVERY CONTENT

- Refrigeration unit
- Tube support
- 2 bells
- Extension table



REFRIGERATED WATER COOLING BELLS UNIT

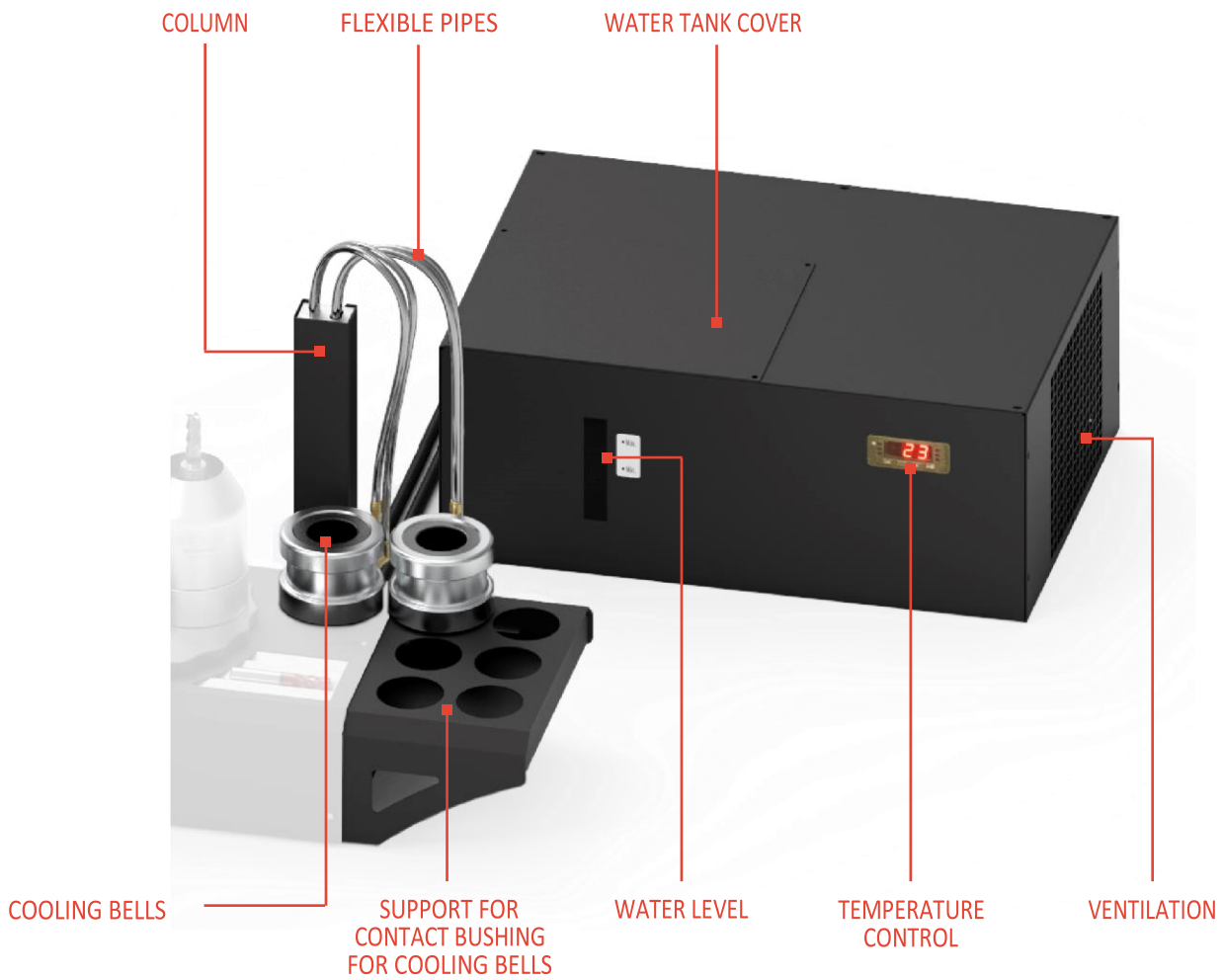

INSTALLATION OF THE REFRIGERATION UNIT



The water cooler must be positioned on a stable working platform with a clearance of 50 cm (19.7") on both sides in order to allow air flow.

MOUNTING THE EXTENSION TABLE

(AVAILABLE AS AN ACCESSORY OR DELIVERED WITH THE WATER-COOLING OPTION)

Tighten the 2 screws **1**.

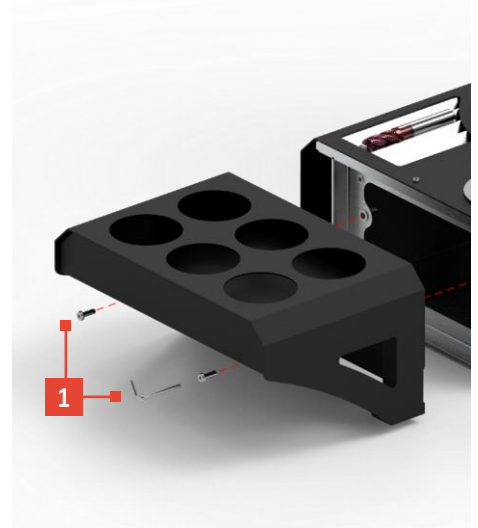

MOUNTING THE COLUMN FOR THE WATER-COOLING TUBES

(DELIVERED WITH THE WATER-COOLING OPTION)

Tighten the 4 screws **2**.

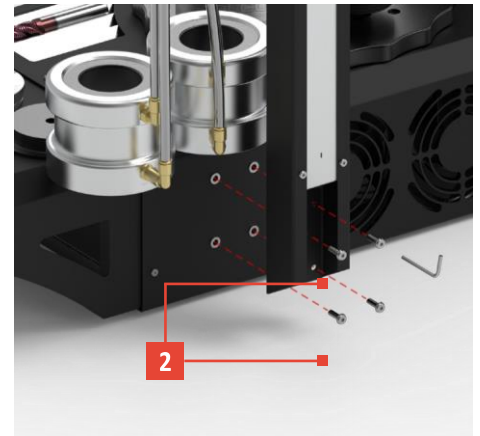

Connect the 2 tubes **3** of the water-cooling system to the connectors of the column.

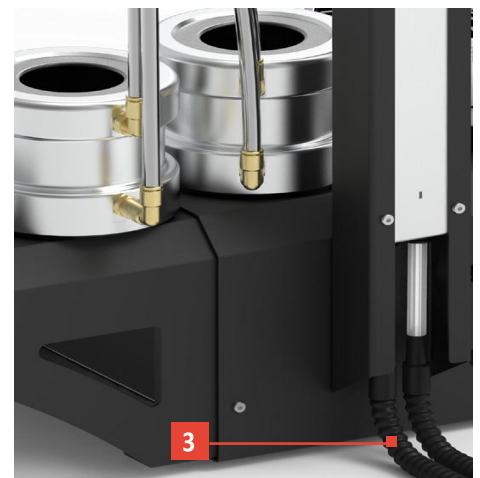

FILLING THE COOLER

Open the cover on the top of the cooler (4 screws to release) **4**.

Fill in the tank with pure water until the indicator shows you that the tank is full.
Tap water: $7.5 < \text{pH} < 9$ / $7^{\circ}\text{C} (44.6^{\circ}\text{F}) < \text{TH} < 15^{\circ}\text{C} (59^{\circ}\text{F})$

Note: change the water approx. every 6 months.



CONNECT THE REFRIGERATED UNIT TO THE TOOLSHRINK EVO

Plug the cable from the refrigerated unit into the outlet **5**

This socket is not installed on Tool Shrink Basic devices that can be connected without a transformer for the 3x440-480V+GND power supply.



Never turn on the power without having filled the cooler first. After first use, it might be necessary to add more water to the tank (check the level). Afterwards, a regular check of the water level and quality is recommended.



WATER TEMPERATURE SETTING

When the power is turned on, the water cooler displays « -88 » for 3 seconds and then displays the temperature of the water.

The water temperature is preset in our plant at +20°C (68°F).

It is adjustable from 10°C to 25°C (50°F to 77°F) **6**.



In the case of noticeable condensation, it is recommended to set the water temperature higher.



To see the preset temperature, press the SET button **7**.

To modify the preset temperature, simultaneously press SET and « up arrow » or « down arrow » **8**.

As soon as the SET button is released, the water temperature is displayed.

The temperature varies between « preset temperature » and « preset temperature + 2° C (35.6°F) ».

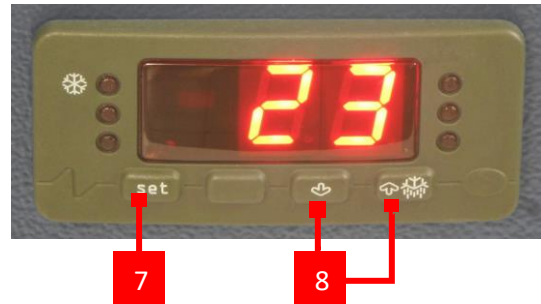

USE

Install the corresponding contact bushing **9** for the cooling bells (Ø and holder type-dependent) onto the top of the holder, and slip over the cooling bell **10**.

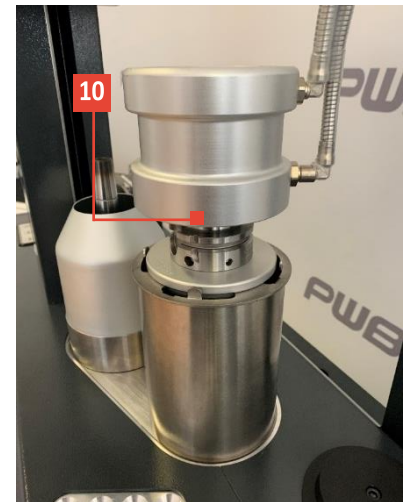

WATER COOLER MAINTENANCE

	FREQUENCY	OBSERVATION
WATER LEVEL CHECK	1 month	
WATER TANK CHECK	6 months	Water ($7.5 < \text{pH} < 9$ and 7°C (44.6°F) $< \text{TH} < 15^{\circ}\text{C}$ (59°F))
RADIATOR CLEANING	2 months	Do not use an air blower

REMARKS

- The tank must only be filled up with pure water (tap water, please refer to recommendations in the table above) and any other product is forbidden (distilled water, demineralised water, glycol etc.).
- If the water cooler will be idle for a long period, the device must be stored in an area at an ambient temperature to avoid any risk of frost.
- Repairs to the refrigeration unit must only be carried out by qualified heating and cooling expert.
- The water cooler must not run with an empty tank.

TAKING DELIVERY

The device you have received has been controlled and tested in our plant according to ISO9001 specifications. If the equipment is being stored or transported under unacceptable conditions it may be permanently damaged. In this case the manufacturer will exclude all warranty claims and obligations.

Unpacking must be carried out carefully to avoid any damage.

A tilt-watch indicator is positioned on the packaging to guaranty the pallet has not been tipped over.

WORKING ENVIRONMENT OF THE DEVICE

The Tool Shrink Basic device needs to be positioned in a dry and clean working area on a stable and rigid surface that is resistant to hot tool holders (+/-100°C (212°F)).

CONNECTIONS

Remark: The transformer for voltages in the USA or Canada is available as an optional accessory.

▪ Power supply:

Take care to use the correct power supply: AC 3 x 400 V (+/-10%) + PEN/16 A/50-60 Hz

AC 3 x 400 V (+/-10%)+N+PE/16 A/50-60 Hz

AC 3 x 440-480 V + GND / 20 A / 50 - 60 Hz

For other voltages the use of a transformer is required, which needs to be bought separately:

- Input voltages: 3 x 208 / 240 / 480 / 600 VAC + GND/28 A /50-60 Hz
- Output voltages: AC 3 x 400 V + PE/28 A/50-60 Hz

▪ Air supply:

- 3 to 6 bar (43 to 87 psi)/pipe external Ø10 mm (Ø0.393") (pipe not supplied)

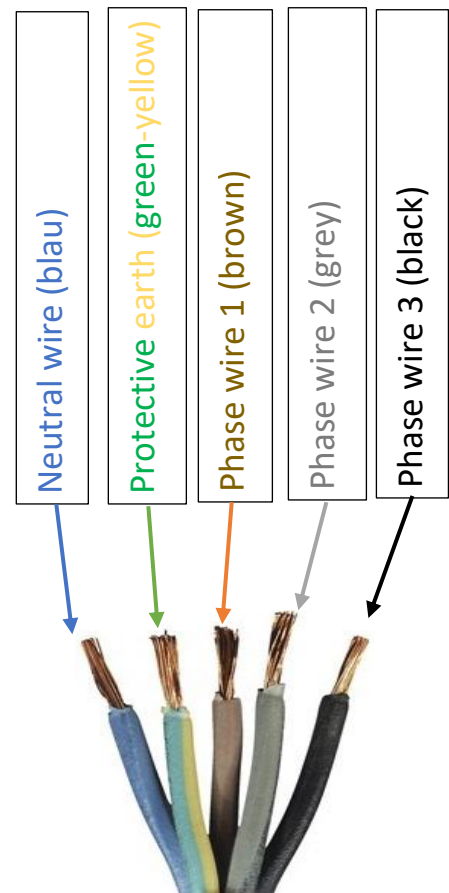

KEYPAD AND DISPLAY PRESENTATION

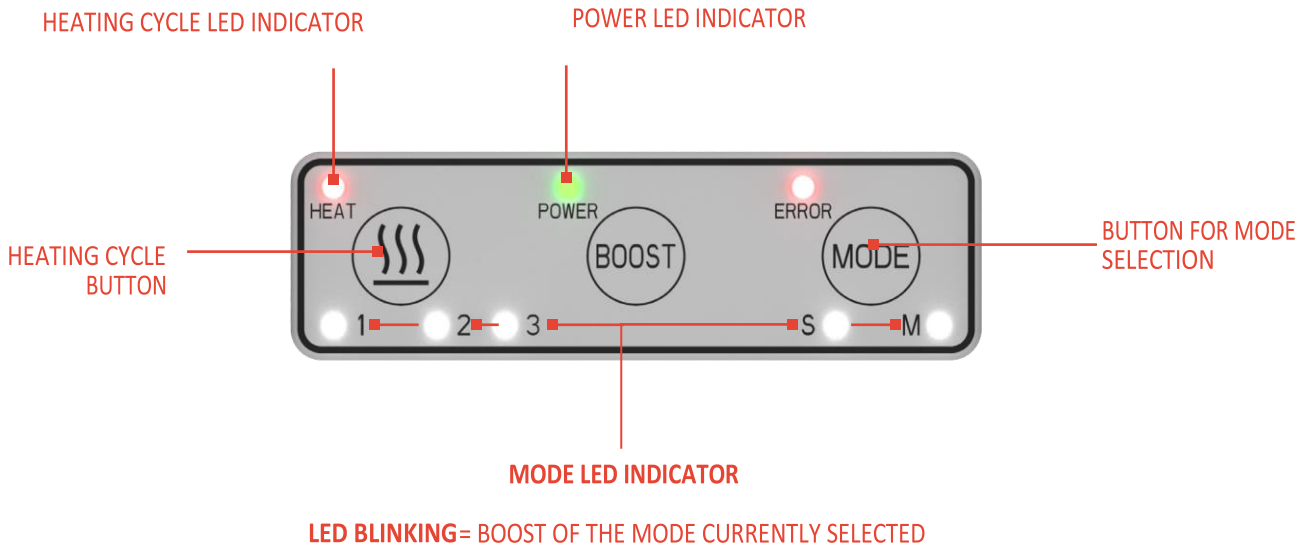

STARTING THE DEVICE

1 2 Switch ON the main interrupter of the Shrinkfit device.

1

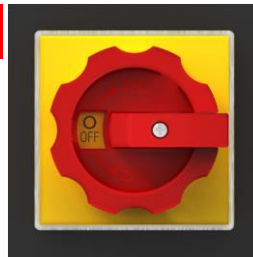

2



3 The Power LED turn ON.

4 After 10 seconds, the Power Led and Mode 1 LED are activated and show that the device is ready to be operated.

3



4



STARTING TO SHRINK AND UNSHRINK



Always wear protective gloves while handling Shrinkfit holders, tools, accessories and spare parts.



Electrical hazard when dismantling module parts



Persons with medical implants are not permitted to use or work with this device. Persons with a pacemaker must refer to the guidelines for their pacemaker established on the basis of: NF EN 60601-1-2 (September 2017)



Do not use hydraulic tool holders on this device as there is a risk of explosion and third-degree burns.

Please notify and provide training to operators who may use this device.

SHRINKFIT TOOL HOLDER & CUTTING TOOLS

The Tool Shrink Basic device makes it easy and safe to perform Shrinkfit tool changes without causing damage to the toolholder or cutting tool, as long as the device is correctly installed and the operating procedures are followed. Tool Shrink Basic is designed to work best with all types of standard Shrinkfit toolholders and efficiently with tools made from steel, HSS, heavy metal or carbide.

Tool shank diameter tolerance is critical.

Tool shank tolerance required:

Ø3 to Ø 5 mm (Ø0.11" to Ø0.19") maximum h5, tool shank must be carbide or heavy metal (e.g. Densimet).

Ø6 to Ø32 mm (Ø0.23" to Ø1.25") maximum h6, tool shank can be steel, HSS, carbide or heavy metal.

Using h5 for Ø6 to Ø32 mm (Ø0.23" to Ø1.25") provides a safer minimum clamping torque.

Make sure the minimum shrinking depth LSC shown in the Product pages for each holder is respected when fitting the tool shank into the holder.

Make sure that the toolholders and the tools are clean, free from grease and dry before being fitted in the device.

SHRINKING DEPTHS TO BE RESPECTED

We recommend the following shrinking depth in order to guarantee the minimum transmittable torque and lifetime of the tool.

EXAMPLE FOR A TYPE SFD DIN 4.5° TOOL HOLDER:

The diameter **DCBX** (tool-fitting size) is indicated in the toolholder specification.

The shrinking depth (depending on the position of the stop end screw) must be set to **LSC** as a minimum.

In this case, the chart indicates **LSC = 39 mm (1.54")**

MINIMUM SHRINKING DEPTH





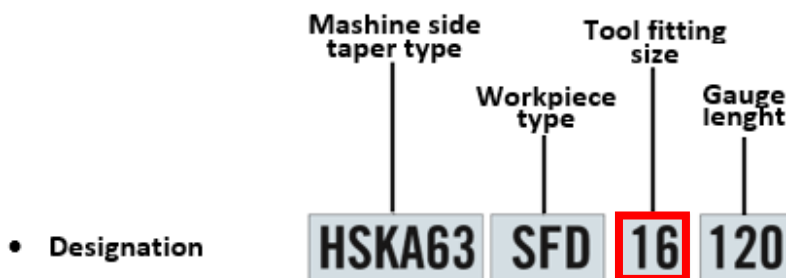



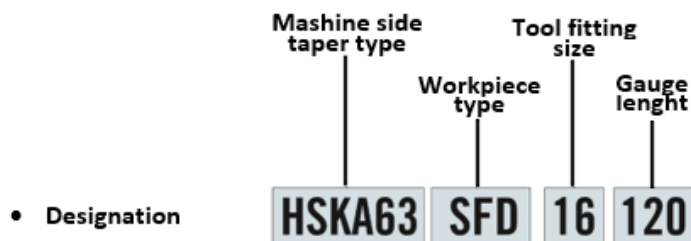

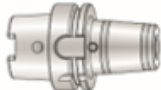

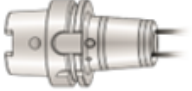



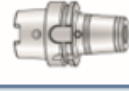

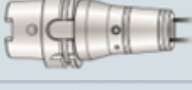
Metric		Inch	
DCBX	LSC Min	DCBX	LSC Min
3	13	1/8"	1/2"
4	15	-	-
5	18	3/16"	3/4"
6	26	1/4"	7/8"
8	30	5/16"	1"3/16"
10	32	3/8"	1"4/4"
12	34	1/2"	1"3/8"
14	34	-	-
16	39	5/8"	1"1/2"
18	39	3/4"	1"5/8"
20	42	7/8"	1"5/8"
25	47	1"	1"7/8"
32	52	1" 1/4"	2"

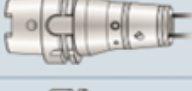

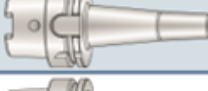
HEATING MODE SELECTION ACCORDING TO MARKING OF:



Workpiece type	DIN type	Designation	Mode	Normal
	DIN: 4.5°	SFD	1	
	DIN: 4.5°	SFD...-L1	1	
 MQL	DIN: 4.5°	SFD...M SFD...M1 SFD...M2	1	
	SPECIAL SHORT*	SPECIAL SHORT*	1	
	DIN: 4.5° Reinforced	SFR	2	
	DIN: 4.5° Safe-Lock™	SFR	2	
	DIN: 3°	SFS	2	
	Zylindrical	Power program	3	
Custom tool holders	Special program	Special program	S	

Immediately move up the inductor after each heating cycle.

SHRINKING PROCESS

1 Place the position ring and the adapter ring corresponding to the type of tool holder on the cooling tube.

2 Select the corresponding heating mode to use depending on the type of tool holder according to the table above.

3 Place the cooling tube with position ring and adapter ring on the base plate hole.

Place the tool holder on the adapter ring.

The cooling tube with the positioning ring and positioning adapter can be used, than a finned support.

4 Take the heat-focusing stopper corresponding to your tool shank diameter and place it in the inductor.

Secure the heat-focusing stopper by turning the heat-focusing stopper a quarter turn into the inductor



5 Move the inductor housing downwards on the holder by pressing the button on the handle.

The heat-focusing stopper must be in contact with the top of the tool holder.

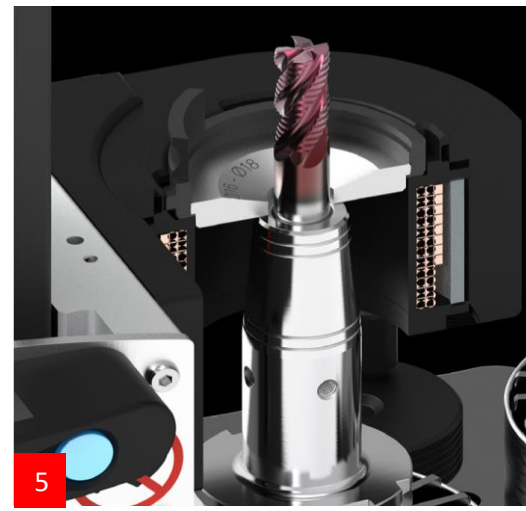

6 Push the Mode button until you reach the corresponding mode shown earlier in the table.

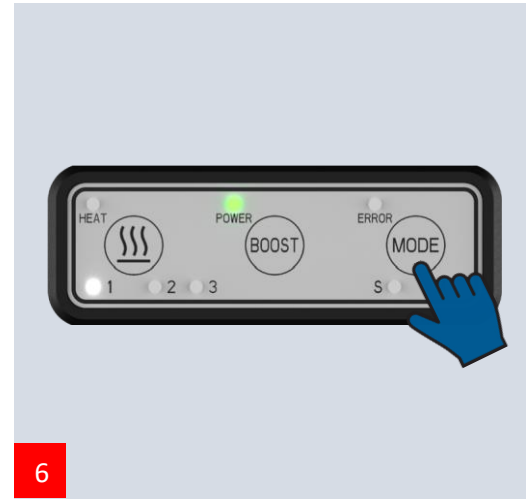

7 Put the protective glove on, take and hold the cutting tool using the glove.



8 Push the Heating cycle button once and wait for the heating cycle LED to go off.

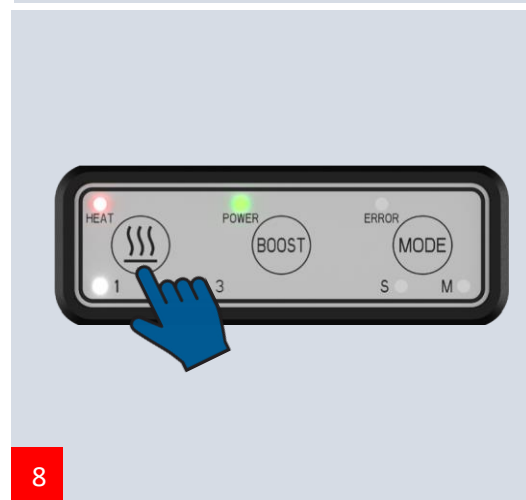

9 Quickly move the inductor housing upwards.

10 Quickly place the tool inside the tool holder and wait for the tool to be correctly clamped.

11 Move the cooling tube together with the tool holder to the other hole on the base plate.

- **With a water-cooling system:** Place the right contact bushing and the cooling bell on the tool holder

- **Without a water-cooling system:** Place the cooling cone



Contact bushing



Air cooling cone



SHRINK RELEASE

The unshrinking process is the same as the shrinking process.

AUDIBLE FEEDBACK

During operation, the device power source generates an audible feedback tone that changes frequency depending on the tool holder size and temperature.

It is not unusual to hear the pitch change as the tool holder temperature increases. Do not be alarmed if you hear this tone, as it is normal.

BOOST MODE

The boost function was made to avoid issues when:

- The cutter tool falls outside the H5/H6 tolerance band
- There is dirt between tool holder and the tool
- Light overheating of the tool holder
- Competitor's shrink and unshrink toolholders with same shape as our standard shape, but with different tolerance on bore

Before using the Boost function, please ensure that your tool holder is not already hot (<30°C (122°F))

Evoset AG is not responsible for misuse of the Boost function.

The Boost function is only for one cycle.

- 1 Push the Mode button until you reach the corresponding mode shown earlier in the table.

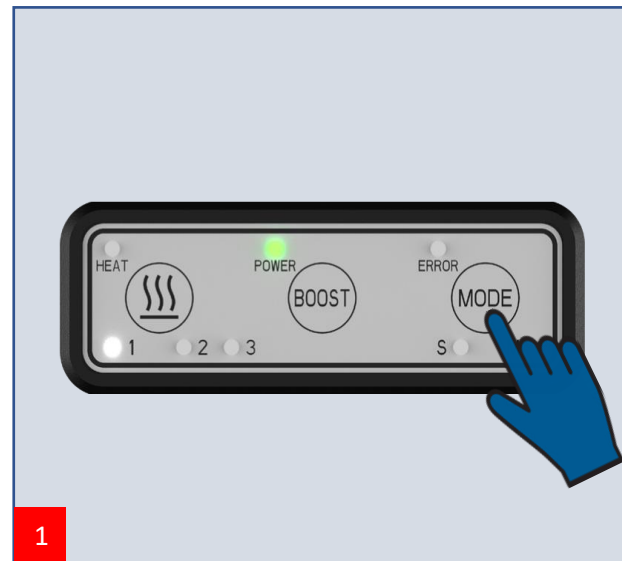

- 2 Push the Boost button once and the LED of the selected mode will blink.

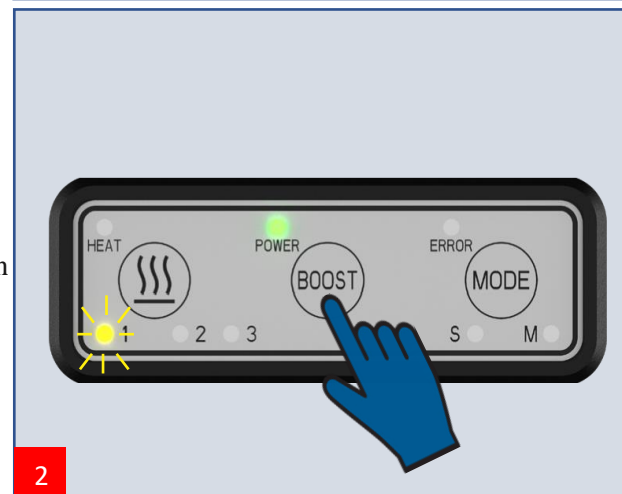

- 3 You are ready to start the heating cycle. Follow the same instruction from step 9 of the shrinking process.

The Boost function can be configured in the web interface. The default Boost function increases the heating time by 20%.

SHRINKING FOR SPECIAL TOOLS

For special tools, e.g. tools with a front end that is larger than the shank, split heat-focusing stoppers are available. The use of split heat-focusing stoppers requires clearance between the tool head and the front face of the tool holder. To successfully shrink/release special tools, it is necessary to observe the following conditions:

- Maximal diameter of the cutter **BD** is 3 x **BD1**
- Ø BD maximum = $\text{Ø}63$ mm ($\text{Ø}2.48$ "
(maximum bore Ø of induction unit)
- **LPR** dimension = 70 mm (2.76") minimum
(due to the inductor housing dimension)
- **LU** dimension changes depending on the tool shank diameter **BD1**



TOOL SHANK Ø MM:	3 (0.12")	4 (0.16")	5 (0.2")	6 (0.24")	8 (0.31")	10 (0.4")	12 (0.47")
LU dimension (mm):	6 (0.24")	6.5 (0.24")	7 (0.27")	7.5 (0.27")	7.5 (0.27")	9 (0.35")	10 (0.39")
TOOL SHANK Ø MM:	14 (0.55")	16 (0.63")	18 (0.71")	20 (0.79")	25 (1")	32 (1.26")	
LU dimension (mm):	11.5 (0.43")	10 (0.39")	11.5 (0.27")	12 (0.47")	9 (0.35")	9 (0.35")	

SHRINKFIT OF SPECIAL TOOLS

1 Place the tool holder in the finned support, or into the adapter ring on the cooling tube.

2 Insert the split heat-focusing stoppers that match the tool shank Ø (see table on previous page) into the location diameter in the inductor housing. (Secure the heat-focusing stopper by turning the heat-focusing stopper a quarter turn into the inductor)

3 Move the inductor housing downwards on the holder by pressing the button on the handle. The heat-focusing stopper must be in contact with the top of the tool holder.

5 split heat-focusing stoppers covering a tool shank diameter of $\text{Ø}32$ ($\text{Ø}0.118$ " to $\text{Ø}1.26$ " are available as accessories with the following capacities: $\text{Ø}3-6$ ($\text{Ø}0.118$ "- 0.236 "), $\text{Ø}8-14$ ($\text{Ø}0.314$ "- 0.551 "), $\text{Ø}16-18$ ($\text{Ø}0.629$ "- 0.708 "), $\text{Ø}20-25$ ($\text{Ø}0.787$ "- 0.984 "), $\text{Ø}32$ ($\text{Ø}1.26$ ").



4 Push the Mode button until you reach the corresponding mode shown earlier in the table.

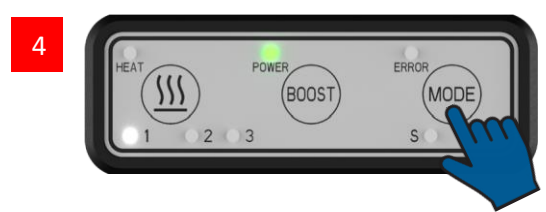

5 Push the Heating cycle button once and wait for the heating cycle LED to go off.

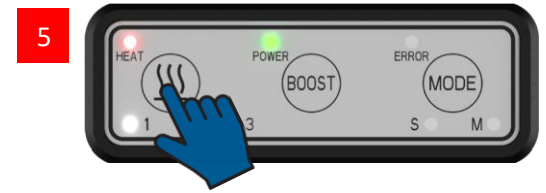

6 Place the tool in the tool holder.



7 After shrinking, move the inductor housing slightly upwards and remove the split heat focusing stopper. (Caution – it may be hot).

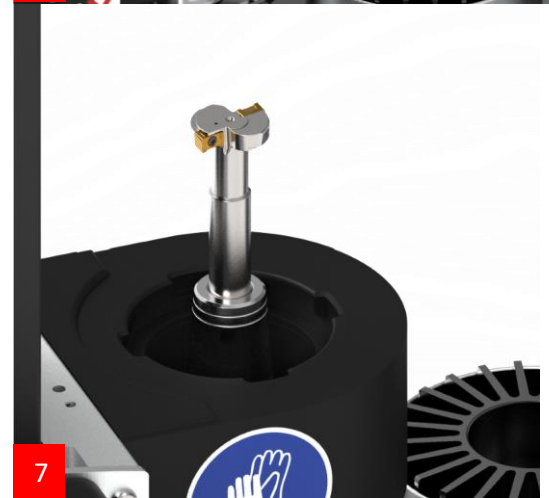

8 Move the inductor housing upwards to allow the toolholder to be removed.



NOTE

The overall height of the inductor housing limits the « LPR » dimension to a minimum of 70 mm (2.76"). Any less than this and it will not be possible to lower the inductor housing sufficiently to gain access to the split heat focusing stopper assembly.

SHRINK RELEASE OF SPECIAL TOOLS

1 Place the tool holder in the finned support, or into the adapter ring on the cooling tube



2 Move the inductor housing below the front face of the toolholder and fit the appropriate split heat-focusing stopper assembly around the shank of the cutting tool. The heat-focusing stopper must be in contact with the top of the tool holder.



3 Push the Mode button until you reach the corresponding mode shown earlier in the table.



4 Push the Heating cycle button once and wait for the heating cycle LED to go off.

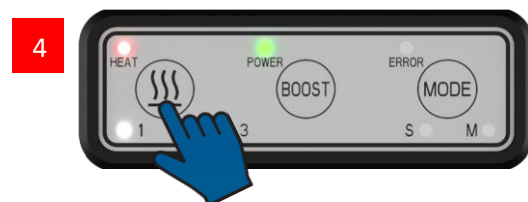

5 Remove the tool from the tool holder. (Caution – it may be hot).



6 Move the inductor housing upwards to allow the toolholder to be removed.



SHRINKING CAPABILITY

SHRINKFIT HOLDER TYPE	Cylindrical Reinforced	Mold maker DIN 3°	Standard DIN 4.5°	Standard DIN 4.5° Reinforced
AVERAGE SHRINKING TIME	6 sec.	2.5 sec.	4 sec.	6 sec.
MINIMUM SHRINKING Ø (TOOL SHANK)	6 mm	3 mm	6 mm	6 mm
MAXIMUM SHRINKING Ø (TOOL SHANK)	32 mm	16 mm	32 mm	32 mm
MAXIMUM Ø OF TOOL WITH FRONT END THAT IS LARGER THAN SHANK	63 mm			
AVERAGE OPEN AIR COOLING TIME	25-35 min.	15-25 min.	20-30 min.	25-35 min.
AVERAGE VENTILATOR STREAMED AIR COOLING TIME	10 min.	5 min.	8 min.	10-15 min.
AVERAGE WATER COOLING TIME	2 min.	1 min.	1.5 min.	2 min.

SHRINKING/UNSHRINKING OF CUSTOM TOOL HOLDERS OR COMPETITOR'S TOOL HOLDERS

The Tool Shrink Basic offers the possibility to set up manual heating programs by using a dedicated web interface.

Please contact your usual Evoset AG partner for detailed information.

WEB INTERFACE

1. ACCESS TO THE WEB INTERFACE

The Tool Shrink Basic allows to you to start a manual program or create an automatic special program on its web interface.

MANUAL PROGRAM:

One-time heating cycle with specific heating time and diffusion time at a certain percentage of heating power.

SPECIAL PROGRAM:

A mode that you can launch directly in the Interface of the device that enables 15 types of tool holders to be set with different heating and time parameters. The only difference from the manual program is automatic detection of the resistance of your custom tool holders.

The device will take the acceptable parameters corresponding to the size and shape of your tool holders and configure them in the table

REQUIRES:

Computer/Smartphone/Tablet with Wi-Fi or Ethernet RJ45 connection

In the case of a Wi-Fi connection:

1. When the device is ON, a Wi-Fi network is automatically created.
2. Connect your computer to it.

Example:

SSID/WI-FI NAME:	Evoset-D7-6F-E3
DEFAULT PASSWORD:	wifievoset

In the case of an Ethernet (RJ45) connection:

1. Shut down the device Power switch.
2. Unscrew the plastic cover **1** on the left-hand side of the device.
3. Behind the device there is a hole entry. Run your RJ45 cable through it **2**
4. Connect the other side of the RJ45 cable to your computer.

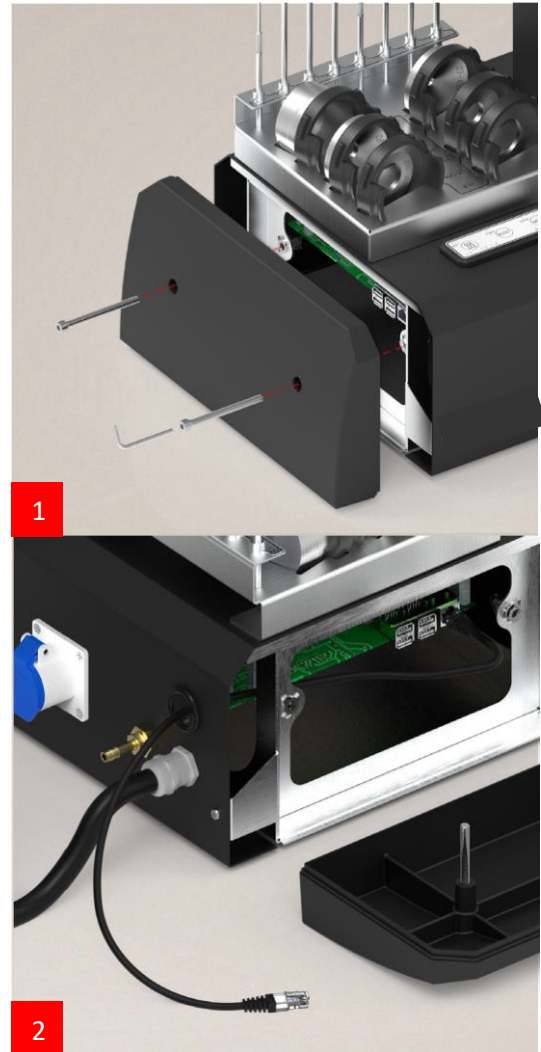

For both types of connection:

1. Open a web browser (e.g. Google Chrome, Internet Explorer, Edge, Firefox...)
2. In the Address Bar (URL), type the IP Address: **172.24.1.1**
3. Press the Enter key.

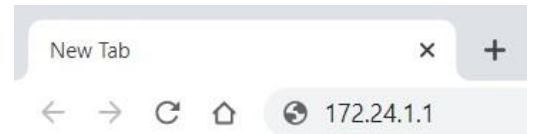

4. The login page will appear (as pictured below).

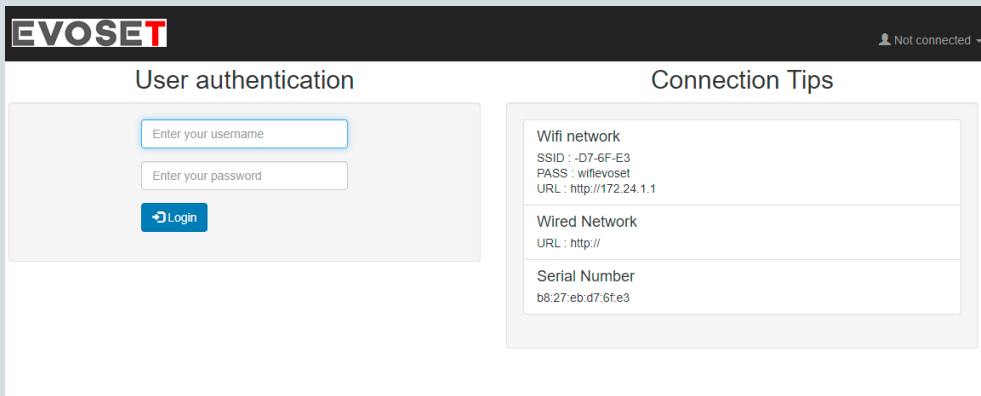

Default username: admin

Default password: admin

5. You now arrive at the main page.

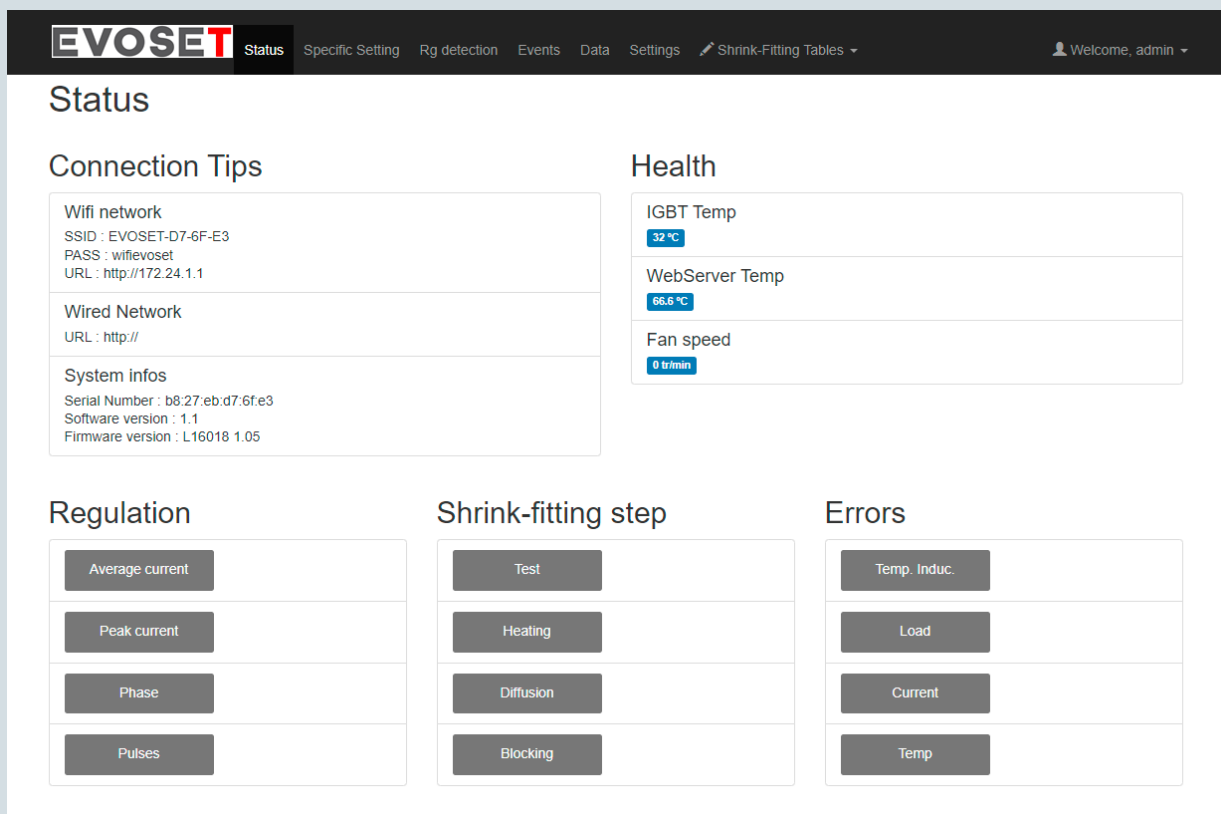

6. All the menu options of the software are available on the menu bar.

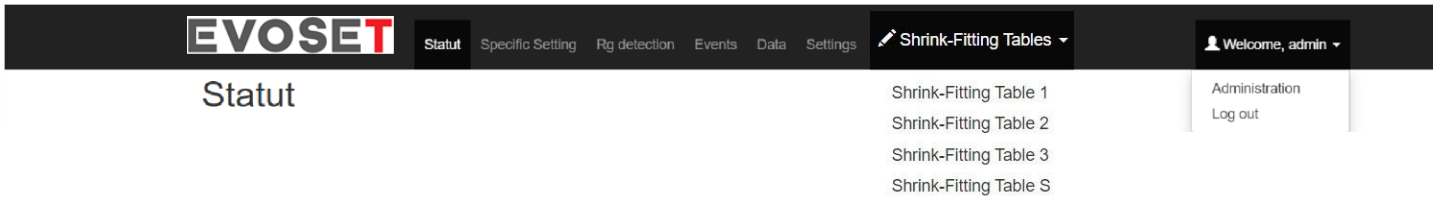

Status	The condition of the unit
Specific setting	Heat program without measuring resistance
Rg detection	Measure the resistance value of the tool holder
Events	All software actions in a log file
Data	The heating process history
Settings	Inductor settings only configured by the supplier
Shrink Fitting Tables	Access to all Shrinkfit table parameters
Shrink Fitting Table 1	Standard DIN 4.5° mode 1 settings
Shrink Fitting Table 2	Standard DIN 3° ; Standard DIN 4.5° reinforced mode 2 settings
Shrink Fitting Table 3	Cylindrical reinforced, Power program mode 3 settings
Shrink Fitting Table S	Settings for custom tool holders with automatic size detection

Welcome	Access to administration settings
Administration	Manage administration settings
Log Out	Disconnect the current web interface user

Administration:
You have 3 menus to manage the whole administration on the web interface

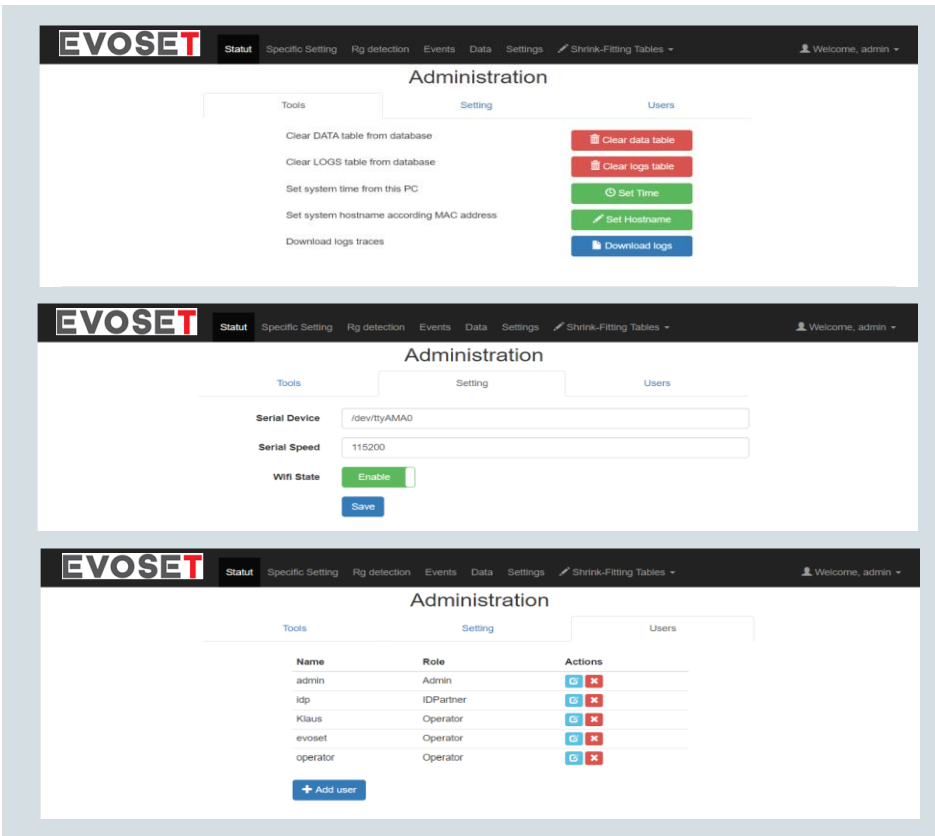

SHRINK FITTING SETTINGS

The screenshot shows the EVOSET software interface for 'Shrink-fitting - Table 1'. The main area is a table with columns for 'R min', 'R max', 'Heating Time 0,1s', 'Heating Current %', 'Diffusion Time 0,1s', and 'Diffusion Current %'. The table contains 17 rows of data. To the right of the table are three panels: 'Testing' with 'State Time 0,1s' (11) and 'State Current %' (100); 'Blocking' with 'State Time 0,1s' (100); and 'Boost' with 'Heating Time 0-100% max' (20), 'Heating Current 0-5% max' (0), 'Diffusion Time 0-100% max' (20), and 'Diffusion Current 0-5% max' (0). At the bottom right, there are buttons for 'Load From File', 'Datei auswählen', 'Keine ausgewählt', 'Write Config', and 'Save to file'.

R min	R max	Heating		Diffusion	
		Time 0,1s	Current %	Time 0,1s	Current %
1000	∞	0	0	0	0
1000	1000	0	0	0	0
1000	1000	0	0	0	0
1000	1000	0	0	0	0
1000	1000	0	0	0	0
1000	1000	0	0	0	0
1000	1000	0	0	0	0
1000	1000	0	0	0	0
250	1000	20	90	25	80
200	250	14	97	16	80
170	200	5	70	23	79
155	170	7	77	21	75
135	155	7	98	9	77
110	135	18	92	8	70
0	110	10	92	2	75

Shrink fitting parameters:

- ⇒ **R min/R max:** Enables different Ø and shapes of Shrinkfit tool holders to be split in comparison with the resistance measured
- ⇒ **Heating Time:** Time value necessary for Shrinkfit tool holders for shrinking or unshrinking according to the measured resistance (expressed as a tenth of a second e.g. 1.1 sec = 11)
- ⇒ **Heating Current:** Power value necessary for Shrinkfit tool holders for shrinking or unshrinking according to the measured resistance (expressed in %)
- ⇒ **Diffusion Time/Current:** The same principle as Heating, the diffusion current is normally lower than the heating current. These parameters allow a certain temperature diffuse to be obtained inside the tool holders in time.

Testing:

This is when the system measures the resistance
NEVER CHANGE THIS POINT

Blocking:

The time between heating the previous tool and the following tool

Boost:

The parameter for the Boost procedure

- ⇒ **Heating Time:** Additional heating time in the shrink fitting settings, in %
- ⇒ **Heating Current:** Additional heating power in the shrink fitting settings, in %
- ⇒ **Diffusion Time:** Additional diffusion time in the shrink fitting settings, in %
- ⇒ **Diffusion Current:** Additional diffusion power in the shrink fitting settings, in %

HOW TO CHECK THE RESISTANCE OF THE TOOL HOLDERS?

- 1) Put your tool holder on the Tool Shrink Evo and prepare everything as for a standard tool holder.
- 2) Move the inductor housing downwards with the correct heat-focusing stopper inside.
- 3) Select the Rg detection menu on the web interface on the menu bar.

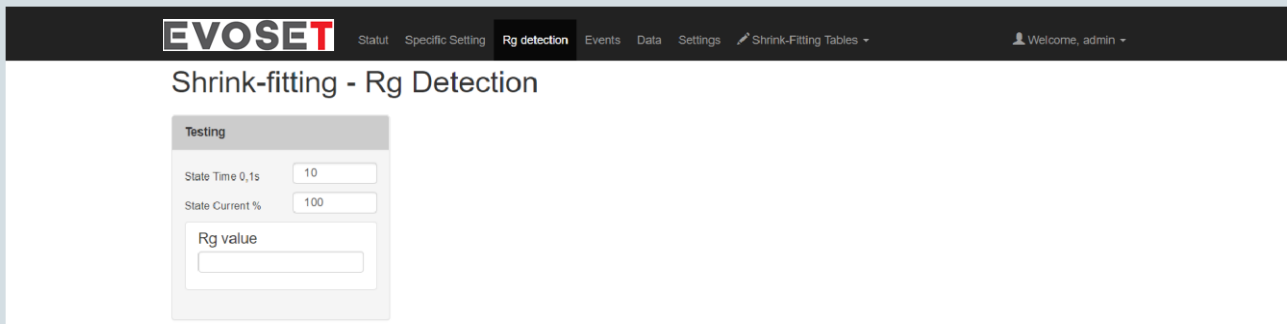

4) The LED mode 1 will automatically be blinking on the interface of the device.





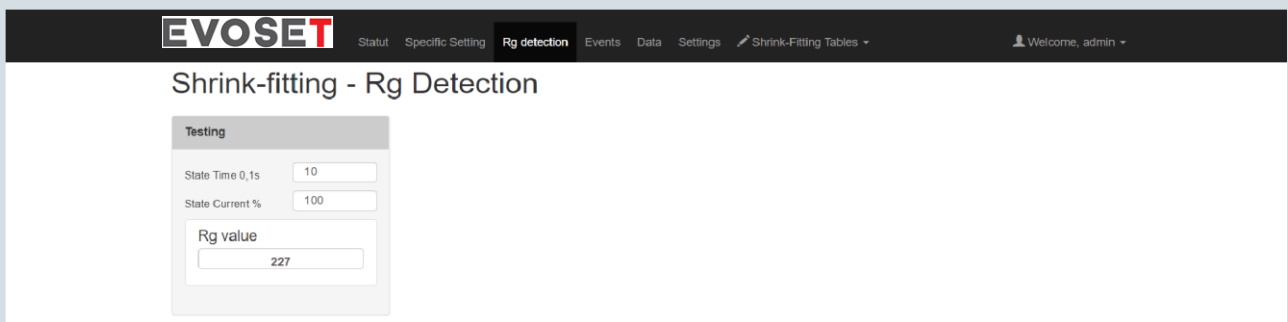









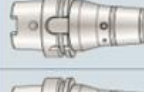

5) Start the heating cycle.

6) The Rg value is normally detected and shown.

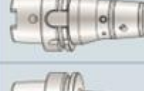

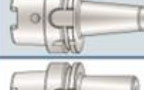
7) Using the Standard Tools holders table, compare the shape of your customer tool holder with the picture in the table and find the equivalent.

8) According to the comparability found, make a note of the mode that corresponds to the shape.

Workpiece type	DIN type	Designation	Mode	Normal
	DIN: 4.5°	SFD	1	
	DIN: 4.5°	SFD...-L1	1	
 MQL	DIN: 4.5°	SFD...M SFD...M1 SFD...M2	1	
	SPECIAL SHORT*	SPECIAL SHORT*	1	
	DIN: 4.5° Reinforced	SFR	2	
	DIN: 4.5° Safe-Lock™	SFR	2	
	DIN: 3°	SFS	2	
	Cylindrical	Power program	3	
Custom tool holders	Special program	Special program	S	

HOW TO ADD SPECIAL TOOL HOLDERS?

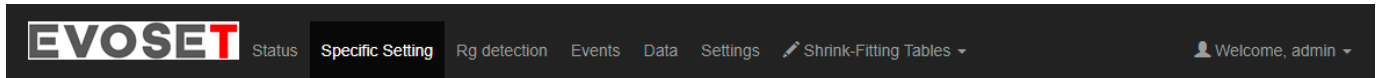

Specific Setting

Enable	Cycle Name	Heating		Diffusion		Action
		Time	Current	Time	Current	
<input checked="" type="checkbox"/>	non magnetic	62 ds	100	0 ds	0	
<input checked="" type="checkbox"/>	Test 30	30 ds	30	30 ds	30	
<input checked="" type="checkbox"/>	Test 20	20 ds	20	20 ds	20	

Disable specific setting

- 1) Add a Cycle **1**, put the Heating/Diffusion parameters and Save **2**.

Example:

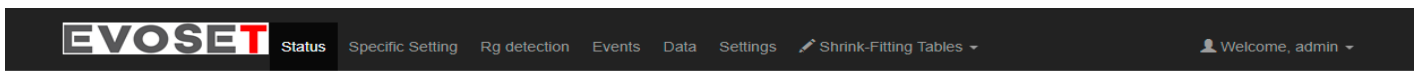

- 2) When you are ready, click on start icon to activate **3**. After activation, you can start the heating cycle on the device.
- 3) Normally the shrinking or unshrinking will be performed easily. If this is not the case, change the parameters by incrementing the value with a little at a time.

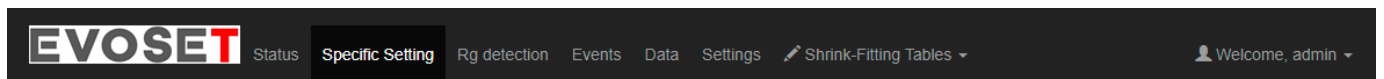

Specific Setting

Enable	Cycle Name	Heating		Diffusion		Action
		Time	Current	Time	Current	
<input checked="" type="checkbox"/>	non magnetic	62 ds	100	0 ds	0	
<input checked="" type="checkbox"/>	Test 30	30 ds	30	30 ds	30	
<input checked="" type="checkbox"/>	Test 20	20 ds	20	20 ds	20	

Disable specific setting

ERROR INFORMATION

If the error LED is ON on the interface or if the device doesn't work properly. You can look at what type of error(s) the device detects on the Status tab of the web interface.

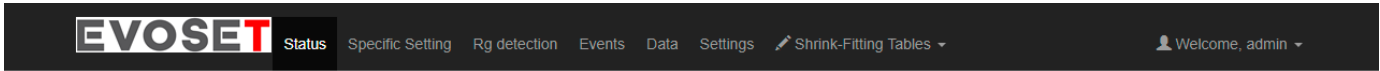

Status

Connection Tips

Wifi network SSID : EVOSET-D7-6F-E3 PASS : wifievoset URL : http://172.24.1.1
Wired Network URL : http://
System infos Serial Number : b8:27:eb:d7:6f:e3 Software version : 1.1 Firmware version : L16018 1.05

Health

IGBT Temp 32 °C
WebServer Temp 66.6 °C
Fan speed 0 tr/min

Regulation

Average current
Peak current
Phase
Pulses

Shrink-fitting step

Test
Heating
Diffusion
Blocking

Errors

Temp. Induc.
Load
Current
Temp

Type of error:

	SUPERVISING	IF RED	DO
TEMP. INDUCT.	Temperature in the inductor	Temperature too high > 70°C	Wait 10 minutes and try again
LOAD	The material in the inductor	Wrong material or wrong tool holder in the inductor	Put a new tool holder in and try again. If the problem persists the Power Card is damaged
CURRENT	Electrical connection	Short circuit in inductor	Check electrical connection and try again If the problem persists the Power Card is damaged
TEMP.	The power card temperature	Temperature too high > 70°C	Wait 10 minutes and try again

DEFAULT VALUES IN THE TABLES

Shrink-fitting - Table 1

Shrink-fitting parameters					
R min	R max	Heating		Diffusion	
		Time 0,1s	Current %	Time 0,1s	Current %
1000	∞	0	0	0	0
1000	1000	0	0	0	0
1000	1000	0	0	0	0
1000	1000	0	0	0	0
1000	1000	0	0	0	0
1000	1000	0	0	0	0
1000	1000	0	0	0	0
1000	1000	0	0	0	0
1000	1000	0	0	0	0
250	1000	20	90	25	80
200	250	14	97	16	80
170	200	5	70	23	79
155	170	7	77	21	75
135	155	7	98	9	77
110	135	18	92	8	70
0	110	10	92	2	75

Testing

State Time 0,1s

State Current %

Blocking

State Time 0,1s

Boost

Heating Time 0-100% max

Heating Current 0-5% max

Difusion Time 0-100% max

Difusion Current 0-5% max

Load From File

Keine ausgewählt

Shrink-fitting - Table 2

Shrink-fitting parameters					
R min	R max	Heating		Diffusion	
		Time 0,1s	Current %	Time 0,1s	Current %
1000	∞	0	0	0	0
1000	1000	0	0	0	0
1000	1000	0	0	0	0
999	1000	0	0	0	0
330	999	65	67	14	75
250	330	65	74	14	74
200	250	20	87	19	87
180	200	14	81	12	87
165	180	11	90	10	86
152	165	10	96	0	0
140	152	10	92	0	0
130	140	10	90	0	0
99	130	11	85	0	0
87	99	3	95	0	0
0	87	2	92	0	0

Testing

State Time 0,1s

State Current %

Blocking

State Time 0,1s

Boost

Heating Time 0-100% max

Heating Current 0-5% max

Difusion Time 0-100% max

Difusion Current 0-5% max

Load From File

Keine ausgewählt

Write Config

Save to file

Shrink-fitting - Table 3

Shrink-fitting parameters					
R min	R max	Heating		Diffusion	
		Time 0,1s	Current %	Time 0,1s	Current %
1000	∞	0	0	0	0
1000	1000	0	0	0	0
1000	1000	0	0	0	0
1000	1000	0	0	0	0
1000	1000	0	0	0	0
1000	1000	0	0	0	0
1000	1000	0	0	0	0
1000	1000	0	0	0	0
280	1000	39	100	21	100
250	280	34	100	14	100
230	250	31	100	11	100
205	230	29	100	11	100
185	205	16	100	13	100
162	185	13	100	12	100
145	162	14	100	7	100
0	145	8	100	7	100

Testing

State Time 0,1s

State Current %

Blocking

State Time 0,1s

Boost

Heating Time 0-100% max

Heating Current 0-5% max

Difusion Time 0-100% max

Difusion Current 0-5% max

Load From File

Keine ausgewählt

MAINTENANCE FREQUENCY

1. DAILY MAINTENANCE

- Clean the device.

- Control the correct running and good condition of the device.

1 Check the condition of the inductors.

2 Check the condition of the heat-focusing plates.



2. MONTHLY MAINTENANCE

3 Check the water level of the water-cooling unit.

4 Check the water temperature.

In the case of significant condensation, it is advisable to slightly increase the water temperature to prevent condensation on the bells and the tool holder.



3. TWICE A YEAR

The water-cooling unit must be drained off.

Turn off the general power supply by pressing the switch at the back of the device.

Open the lid on the top of the water-cooling unit (4 screws to be removed).

Simultaneously pull the 2 white pull studs in opposite directions in order to open the tank then empty the tank.

Wastewater is considered to be polluted and must be treated according to environmental constraints.

Fill the tank up with pure tap water until the indicated level is reached ($7.5 < \text{pH} < 9$ / 7°C (44.6°F) $< \text{TH} < 15^{\circ}\text{C}$ (59°F)).

Close the tank again, replace the lid and screw it back.

Switch on the general switch at the back of the device.



SAFETY PRECAUTIONS

This shrinking device is only intended for professional use.

Take care to use the correct power supply:

AC 3 x 400 V (+/-10%) + PEN/16 A/50-60 Hz

AC 3 x 400 V (+/-10%)+N+PE/16 A/50-60 Hz

AC 3 x 440-480 V + GND / 20 A / 50 - 60 Hz

For other voltages the use of a transformer is required, which needs to be bought separately:

- Input voltages: 3 x 208 / 240 / 480 / 600 VAC + GND/28 A /50-60 Hz
- Output voltages: AC 3 x 400 V + PE/28 A/50-60 Hz

The power supply for the refrigeration unit is: 1 x 230 V+N + PE/16 A/50 Hz. (WKL7; 0007.013)
1x120V+PE/15A/60Hz. (WKL7; 0007.016)

The Shrinkfit holder becomes very hot during operation. Touching this spot may cause serious burns. Always wear gloves when handling Shrinkfit holders.

Persons with medical implants are not permitted to use or work with this device. Persons with pacemakers must refer to the guidelines of their pacemaker established on the basis of: NF EN 60601-1-2 (September 2007).

Repairs to the shrinking devices should only be carried out by skilled operators. Please contact your Evoset AG Sales Unit.

Only trained and authorized persons are permitted to use the shrinking devices.

RECOMMENDATIONS FOR USE AND MAINTENANCE

Always make sure the holder has cooled down prior to shrink grip or shrink release.

The holder and the tool must be clean, free from grease and dry before being fitted to the device. Before starting the shrinking process, please always check if:

- The power supply is sufficient
- The length has been set correctly, with the correct stop rod
- The correct heat-focusing stopper has been chosen
- Recommended cylindrical tool shank tolerance is h5 or h6 (maximum h5 for Ø3 (Ø0.118") to Ø5 mm (Ø0.196"), maximum h6 for Ø6 (Ø0.236") to Ø32 mm (Ø1.26"))
- The tool shank is not damaged

Keep the device and its environment clean to ensure a long service life.

The device can only be used for the purposes defined in this operating manual. Evoset AG cannot be held responsible for casualties caused by any other use.

Maintenance is limited to regular cleaning of the device and accessories with adapted products.

SAFETY FUNCTIONS OF THE HEATING MODULE

- The inductor is equipped with a sensor to avoid overheating of the inductor and if the temperature limit is reached the Interface will be not available.
- To increase the service life of the holders, the electronics of the device have been programmed to allow only one main heating process, which it automatically cuts off after use. A programmed delay is then activated before the heat cycle function can be repeated.

ANNEXES

Technical features

Compliance declaration for heating modules, support and cooling boxes (to fill in)

Certificate

TECHNICAL FEATURES

Tool Shrink Basic:

Voltage	AC 3 x 400 V (+/-10%) + PEN/23.8 A/50-60 Hz AC 3 x 400 V (+/-10%)+N+PE/23.8 A/50-60 Hz AC 3 x 440-480 V + GND / 23.8 A / 50 - 60 Hz
Power	AC 3x400V 16 500 VA AC 3x480V 19800 VA
Frequency	50-60 Hz
Weight	46.2 kg (102 lbs)

1. Prevent condensation and frost
2. Air humidity when the temperature of the device slowly increases to 40°C (104°F) or quickly passes from -20 (-4°F) to +30°C (86°F)
3. At a maximum of 2000 m (6500 feet) above sea level

Refrigerated water-cooling bells unit

WKL7; 0007.013

Media to be cooled	Water
Flow rate of media	3.0 l/min 1.7 bar (24 psi)
Operating pressure max.	3.5 bar (51 psi)
Ambient temperature	10.0°C (50°F) to 35.0°C (95°F)
Refrigerant	R134a 0.310 kg (0.682 lbs)
Voltage	1 x 230 V +N+ PE
Ext. on/off signal	24 VDC
Frequency	50 Hz
Power	850 VA
Weight (without water)	39.8 kg (88 lbs)

WKL7; 0007.016

Media to be cooled	NALCO® CCL100
Flow rate of media	2.2 l/min 4.5 bar (62.268 psi)
Operating pressure max.	5 bar (72.52 psi)
Ambient temperature	10.0°C (50°F) to 35.0°C (95°F)
Refrigerant	R134a 0.70 kg (1.543 lbs)
Voltage	1 x 120 V + PE
Frequency	60 Hz
Power	1400 VA
Weight (without water)	42 kg (92.594 lbs)

to the directives:

- 2014/30/EU " Electromagnetic Compatibility "
- 2014/35/EU " Low Voltage Directive "
- 2006/42/EC " Machine Directives "

We declare that the product:

TOOLSHRINKAutomatic vertical shrinking/unshrinking device
by induction heating
for fretting tool holders

Reference

complies with the essential requirements of the directives:

- 2014/30/EU
- 2014/35/EU
- 2006/42/EC

based on the following standards:

- NF EN 61000-4-2 (2009)
- NF EN 61000-4-3 (2006)/ A1 (2008)/ A2 (2011)
- NF EN 61000-4-4 (2013)
- NF EN 61000-4-5 (2014)/ A1 (2017)
- NF EN 61000-4-6 (2014)
- NF EN IEC 61000-4-11 (2020)
- NF EN IEC 61000-6-2 (2019)
- NF EN 55011 (2016) A1 (2017)
- EN IEC 60204-1

CH-3940 Steg VS, 28.04.2022

Stevan Vukicevic
Managing Director - EVOSET AG
CH-3940 Steg VS

to the directives:

- 2014/30/EU " Electromagnetic Compatibility "
- 2014/35/EU " Low Voltage Directive "
- 2006/42/EC " Machine Directives "

We declare that the product:

TOOLSHRINK

Cooling module

Reference:

complies with the essential requirements of the directives:

- 2014/30/EU
- 2014/35/EU
- 2006/42/EC

based on the following standards:

- NF EN 61000-6-2 (January 2006)
- NF EN 61000-6-4 (March 2007) A1 (May 2011)
- NF EN 60204-1 (September 2006) A1 (May 2009)

CH-3940 Steg VS, 28.04.2022

Stevan Vukicevic
Managing Director - EVOSET AG
CH-3940 Steg VS